













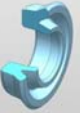

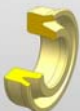

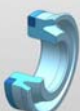

guillard+dörr
DICHTUNGS- UND KUNSTSTOFFTECHNIK

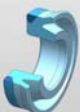
SEALS OVERVIEW
STATE 2012.03.16















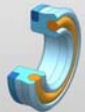

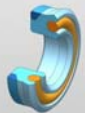
Fluid Pneumatic Seals – Piston Seals

Page 1 of 7 · State: 2012.03.16

Product standard application		Direction mouse over symbol	Pressure maximum	Sliding Speed. maximum
		Piston Seal, TK01P Hydraulic, single acting	400 bar	0,7 m/s
		Piston Seal, TK01PE Hydraulic, single acting	400 bar	0,7 m/s
		Piston Seal, TK01R Hydraulic, single acting	160 bar	0,5 m/s
		Piston Seal, TK01RE Hydraulic, single acting	160 bar	0,5 m/s
		Piston Seal, TK02P Hydraulic, single acting	700 bar	0,7 m/s
		Piston Seal, TK02PD Hydraulic, single acting	700 bar	0,7 m/s
		Piston Seal, TK02R Hydraulic, single acting	250 bar	0,5 m/s
		Piston Seal, TK02RD Hydraulic, single acting	250 bar	0,5 m/s
		Piston Seal, TK03F Food-, Pharmaceutical- and Chemical industry, single-acting	400 bar	1 m/s

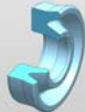
Fluid Pneumatic Seals – Piston Seals

Page 2 of 7 · State: 2012.03.16

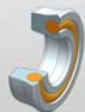
Product standard application		Direction mouse over symbol	Pressure maximum	Sliding Speed. maximum
		Piston Seal, TK03FS Food-, Pharmaceutical- and Chemical industry, single-acting	400 bar	1 m/s
		Piston Seal, TK03P Hydraulic, single acting	400 bar	0,7 m/s
		Piston Seal, TK04P Hydraulic, single acting	700 bar	0,7 m/s
		Piston Seal, TK04PD Hydraulic, single acting	700 bar	0,7 m/s
		Piston Seal, TK05P Pneumatic, single acting	25 bar	2 m/s
		Piston Seal, TK05R Pneumatic, single acting	25 bar	1 m/s
		Piston Seal, TK06P Hydraulic, single acting	400 bar	0,7 m/s
		Piston Seal, TK06R Hydraulic, single acting	160 bar	0,5 m/s
		Piston Seal, TK07F Food-, Pharmaceutical- and Chemical industry, single-acting	400 bar	1 m/s













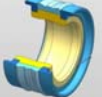

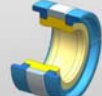

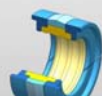
Fluid Pneumatic Seals – Piston Seals

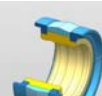
Page 3 of 7 · State: 2012.03.16

Product standard application		Direction mouse over symbol	Pressure maximum	Sliding Speed. maximum
		Piston Seal, TK07P Hydraulic, single acting	400 bar	0,7 m/s
		Piston Seal, TK08D/F Hydraulic, double acting	600 bar	10 m/s
		Piston Seal, TK08D/X Hydraulic, double acting	600 bar	5 m/s
		Piston Seal, TK08DS/F Hydraulic, double acting	600 bar	10 m/s
		Piston Seal, TK08DS/X Hydraulic, double acting	600 bar	5 m/s
		Piston Seal, TK08E/F Hydraulic, single acting	600 bar	10 m/s
		Piston Seal, TK08E/X Hydraulic, single acting	600 bar	5 m/s
		Piston Seal, TK08ES/F Hydraulic, single acting	600 bar	10 m/s
		Piston Seal, TK08ES/X Hydraulic, single acting	600 bar	5 m/s



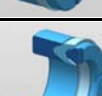







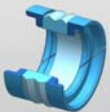
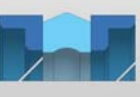
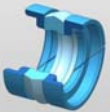

Fluid Pneumatic Seals – Piston Seals

Page 4 of 7 · State: 2012.03.16

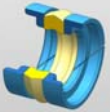
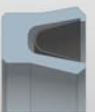





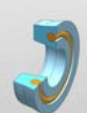



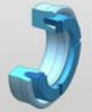

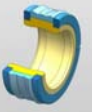

Product standard application		Direction mouse over symbol	Pressure maximum	Sliding Speed. maximum
		Piston Seal, TK08P Hydraulic, double acting	250 bar	1,4 m/s
		Piston Seal, TK09D Hydraulic, double acting	400 bar	0,7 m/s
		Piston Seal, TK09F Hydraulic, double acting	400 bar	1,5 m/s
		Piston Seal, TK09H Hydraulic, double acting	1500 bar	0,3 m/s
		Piston Seal, TK09N Hydraulic, double acting	400 bar	0,7 m/s
		Piston Seal, TK10M Hydraulic, single acting	500 bar	0,7 m/s
		Piston Seal, TK10T Hydraulic, single acting	500 bar	0,7 m/s
		Piston Seal, TK13T Hydraulic, single acting	600 bar	0,7 m/s
		Piston Seal, TK15P Hydraulic, double acting	400 bar	-

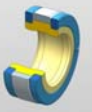
Fluid Pneumatic Seals – Piston Seals

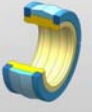
Page 5 of 7 · State: 2012.03.16



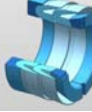

Product standard application		Direction mouse over symbol	Pressure maximum	Sliding Speed. maximum
		Piston Seal, TK16A Hydraulic / pneumatic, single acting	160 bar	5 m/s
		Piston Seal, TK16B Hydraulic / pneumatic, single acting	160 bar	5 m/s
		Piston Seal, TK17H Hydraulic, double acting	250 bar	0,7 m/s
		Piston Seal, TK17P Hydraulic, double acting	250 bar	0,7 m/s
		Piston Seal, TK17R Hydraulic, double acting	250 bar	0,5 m/s
		Piston Seal, TK19F Food-, Pharmaceutical and- Chemical industry, single-acting	400 bar	15 m/s
		Piston Seal, TK20E Hydraulic, single acting	700 bar	0,5 m/s
		Piston Seal, TK20R Hydraulic, double acting	700 bar	0,5 m/s
		Piston Seal, TK21P Hydraulic, single acting	400 bar	0,7 m/s

Fluid Pneumatic Seals – Piston Seals

Product standard application		Direction mouse over symbol	Pressure maximum	Sliding Speed. maximum
		Piston Seal, TK22P Hydraulic, single acting	400 bar	0,7 m/s
		Piston Seal, TK22R Hydraulic, single acting	160 bar	0,5 m/s
		Piston Seal, TK23D Hydraulic, double acting	400 bar	0,7 m/s
		Piston Seal, TK23F Hydraulic, double acting	400 bar	1,5 m/s
		Piston Seal, TK23H Hydraulic, double acting	1500 bar	0,4 m/s
		Piston Seal, TK23N Hydraulic, double acting	400 bar	0,7 m/s
		Piston Seal, TK24P Hydraulic, single acting	500 bar	0,7 m/s
		Piston Seal, TK32P Hydraulic, single acting	500 bar	0,7 m/s
		Piston Seal, TK35P Hydraulic, double acting	400 bar	0,5 m/s





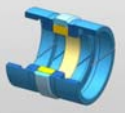











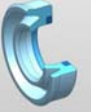







Fluid Pneumatic Seals – Piston Seals

Page 7 of 7 · State: 2012.03.16

Product standard application		Direction mouse over symbol	Pressure maximum	Sliding Speed. maximum
		Piston Seal, TK37P Hydraulic, double acting	50 bar	–
		Piston Seal, TK37R Hydraulic, double acting	50 bar	–
		Piston Seal, TK50 Hydraulic, double acting	360 bar	1 m/s

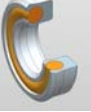

















Fluid Pneumatic Seals – Rod Seals

Page 1 of 6 · State: 2012.03.16

Product standard application			Direction mouse over symbol	Pressure maximum	Sliding Speed. maximum
		Rod Seal, TS01P Hydraulic, single acting		400 bar	0,7 m/s
		Rod Seal, TS01R Hydraulic, single acting		160 bar	0,5 m/s
		Rod Seal, TS02P Hydraulic, single acting		700 bar	0,7 m/s
		Rod Seal, TS02PD Hydraulic, single acting		700 bar	0,7 m/s
		Rod Seal, TS02PS Hydraulic, single acting		400 bar	0,7 m/s
		Rod Seal, TS02R Hydraulic, single acting		250 bar	0,5 m/s
		Rod Seal, TS02RD Hydraulic, single acting		250 bar	0,5 m/s
		Rod Seal, TS03F Food-, Pharmaceutical and- Chemical industry, single-acting		400 bar	1 m/s
		Rod Seal, TS03FS Food-, Pharmaceutical and- Chemical industry, single-acting		400 bar	1 m/s



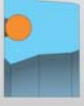







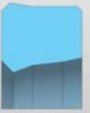





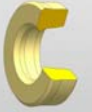









Fluid Pneumatic Seals – Rod Seals

Page 2 of 6 · State: 2012.03.16

Product standard application		Direction mouse over symbol	Pressure maximum	Sliding Speed. maximum
		Rod Seal, TS03P Hydraulic, single acting	400 bar	0,7 m/s
		Rod Seal, TS04P Hydraulic, single acting	700 bar	0,7 m/s
		Rod Seal, TS04PD Hydraulic, single acting	700 bar	0,7 m/s
		Rod Seal, TS05P Pneumatic, single acting	25 bar	2 m/s
		Rod Seal, TS05R Pneumatic, single acting	25 bar	1 m/s
		Rod Seal, TS06P Hydraulic, single acting	400 bar	0,7 m/s
		Rod Seal, TS06R Hydraulic, single acting	160 bar	0,5 m/s
		Rod Seal, TS07F Food-, Pharmaceutical and- Chemical industry, single-acting	400 bar	1 m/s
		Rod Seal, TS07P Hydraulic, single acting	400 bar	0,7 m/s

























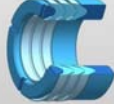

Fluid Pneumatic Seals – Rod Seals

Page 3 of 6 · State: 2012.03.16

Product standard application			Direction mouse over symbol	Pressure maximum	Sliding Speed. maximum
		Rod Seal, TS08P Hydraulic, single acting		400 bar	0,4 m/s
		Rod Seal, TS08PE Hydraulic, single acting		400 bar	0,4 m/s
		Rod Seal, TS08R Hydraulic, single acting		160 bar	0,3 m/s
		Rod Seal, TS09D/F Hydraulic, double acting		600 bar	10 m/s
		Rod Seal, TS09D/X Hydraulic, double acting		600 bar	5 m/s
		Rod Seal, TS09DS/F Hydraulic, double acting		600 bar	10 m/s
		Rod Seal, TS09DS/X Hydraulic, double acting		600 bar	5 m/s
		Rod Seal, TS09E/F Hydraulic, single acting		600 bar	10 m/s
		Rod Seal, TS09E/X Hydraulic, single acting		600 bar	5 m/s















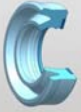

Fluid Pneumatic Seals – Rod Seals

Page 4 of 6 · State: 2012.03.16

Product standard application			Direction mouse over symbol	Pressure maximum	Sliding Speed. maximum
		Rod Seal, TS09ES/F Hydraulic, single acting		600 bar	10 m/s
		Rod Seal, TS09ES/X Hydraulic, single acting		600 bar	5 m/s
		Rod Seal, TS09P Hydraulic, single acting		250 bar	1,4 m/s
		Rod Seal, TS10M Hydraulic, single acting		500 bar	0,7 m/s
		Rod Seal, TS10T Hydraulic, single acting		500 bar	0,7 m/s
		Rod Seal, TS13T Hydraulic, single acting		500 bar	0,7 m/s
		Rod Seal, TS15P Hydraulic, single acting		400 bar	-
		Rod Seal, TS16A Hydraulic / Pneumatic, single acting		160 bar	5 m/s
		Rod Seal, TS16B Hydraulic / Pneumatic, single acting		160 bar	5 m/s

Fluid Pneumatic Seals – Rod Seals

Page 5 of 6 · State: 2012.03.16

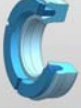
Product standard application		Direction mouse over symbol	Pressure maximum	Sliding Speed. maximum
		Rod Seal, TS17P Hydraulic, single acting	400 bar	0,7 m/s
		Rod Seal, TS17R Hydraulic, single acting	160 bar	0,5 m/s
		Rod Seal, TS18P Hydraulic, single acting	600 bar	0,7 m/s
		Rod Seal, TS18R Hydraulic, single acting	250 bar	0,5 m/s
		Rod Seal, TS19F Food-, Pharmaceutical and- Chemical industry, single-acting	400 bar	15 m/s
		Rod Seal, TS20E Hydraulic, single acting	700 bar	0,5 m/s
		Rod Seal, TS20R Hydraulic, double acting	700 bar	0,5 m/s
		Rod Seal, TS21P Hydraulic, single acting	400 bar	0,7 m/s
		Rod Seal, TS22P Hydraulic, single acting	400 bar	0,7 m/s











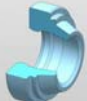

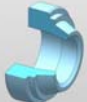

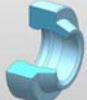

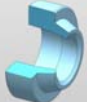
Fluid Pneumatic Seals – Rod Seals

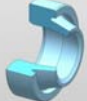
Page 6 of 6 · State: 2012.03.16

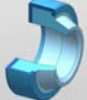
Product standard application		Direction mouse over symbol	Pressure maximum	Sliding Speed. maximum
		Rod Seal, TS22R Hydraulic, single acting	160 bar	0,5 m/s
		Rod Seal, TS24P Hydraulic, single acting	700 bar	0,7 m/s
		Rod Seal, TS25F Food-, Pharmaceutical and- Chemical industry, single-acting	100 bar	1,5 m/s
		Rod Seal, TS29F Food-, Pharmaceutical and- Chemical industry, single-acting	315 bar	1,5 m/s
		Rod Seal, TS32P Hydraulic, single acting	500 bar	0,7 m/s
		Rod Seal, TS35P Hydraulic, double acting	400 bar	0,5 m/s
		Rod Seal, TS37P Hydraulic, double acting	50 bar	-
		Rod Seal, TS37R Hydraulic, double acting	50 bar	-

















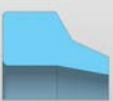

Fluid Pneumatic Seals – Wipers

Page 1 of 4 · State: 2012.03.16

Product standard application		Direction mouse over symbol	Pressure maximum	Sliding Speed. maximum
		Wiper, TA01A Hydraulic, single acting	–	5 m/s
		Wiper, TA01B Hydraulic, single acting	–	5 m/s
		Wiper, TA02A Hydraulic, single acting	–	5 m/s
		Wiper, TA02B Hydraulic, single acting	–	5 m/s
		Wiper, TA02I Hydraulic, single acting	–	5 m/s
		Wiper, TA03 Hydraulic, single acting	–	5 m/s
		Wiper, TA04A Pneumatic, single acting	–	5 m/s
		Wiper, TA04B Pneumatic, single acting	–	5 m/s
		Wiper, TA05A Pneumatic, single acting	–	5 m/s



















Fluid Pneumatic Seals – Wipers

Page 2 of 4 · State: 2012.03.16

Product standard application		Direction mouse over symbol	Pressure maximum	Sliding Speed. maximum
		Wiper, TA05B Pneumatic, single acting	–	5 m/s
		Wiper, TA05I Pneumatic, single acting	–	5 m/s
		Wiper, TA06 Pneumatic, single acting	–	5 m/s
		Wiper, TA07 Hydraulic, single acting	–	5 m/s
		Wiper, TA08A Hydraulic / Pneumatic, single acting	–	5 m/s
		Wiper, TA08B Hydraulic / Pneumatic, single acting	–	5 m/s
		Wiper, TA09 Hydraulic, single acting	–	5 m/s
		Wiper, TA10 Hydraulic, single acting	–	5 m/s
		Wiper, TA11A Hydraulic / Pneumatic, double acting	–	5 m/s







Fluid Pneumatic Seals – Wipers

Page 3 of 4 · State: 2012.03.16

Product standard application		Direction mouse over symbol	Pressure maximum	Sliding Speed. maximum
		Wiper, TA11I Hydraulic / Pneumatic, double acting	–	5 m/s
		Wiper, TA12A Hydraulic, single acting	–	5 m/s
		Wiper, TA12B Hydraulic, double acting	–	5 m/s
		Wiper, TA12C Hydraulic / Pneumatic, double acting	–	1 m/s
		Wiper, TA13 Hydraulic / Pneumatic, single acting	–	5 m/s
		Wiper, TA16 Hydraulic / Pneumatic, double acting	–	–
		Wiper, TA17 Hydraulic / Pneumatic, single acting	–	0,7 m/s
		Wiper, TA18P Hydraulic / Pneumatic, single acting	–	5 m/s
		Wiper, TA19 Hydraulic / Pneumatic, single acting	–	5 m/s

Fluid Pneumatic Seals – Wipers

Page 4 of 4 · State: 2012.03.16

Product standard application			Direction mouse over symbol	Pressure maximum	Sliding Speed. maximum
		Wiper, TA25F Hydraulic / Pneumatic, single acting		–	10 m/s
		Wiper, TA26F Hydraulic / Pneumatic, double acting		–	10 m/s

Fluid Pneumatic Seals – Guide Ring Systems







Product standard application			Direction mouse over symbol	Pressure maximum	Sliding Speed. maximum
		Guide Ring, TF01 Hydraulics / Pneumatics general Application		-	-
		Guide Ring, TF01G Hydraulics / Pneumatics general Application		-	-
		Guide Ring, TF02 Hydraulics / Pneumatics general Application		-	-
		Guide Ring, TF02G Hydraulics / Pneumatics general Application		-	-
		Guide Ring, TF03 Hydraulics / Pneumatics general Application		-	-
		Guide Ring, TF03G Hydraulics / Pneumatics general Application		-	-
		Guide Ring, TF04 Hydraulics / Pneumatics general Application		-	-
		Guide Ring, TF04G Hydraulics / Pneumatics general Application		-	-
		Guide Ring, TF05 Hydraulics / Pneumatics general Application		-	-

Fluid Pneumatic Seals – Guide Ring Systems



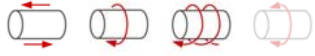

Product standard application		Direction mouse over symbol	Pressure maximum	Sliding Speed. maximum
		Guide Ring, TF05G Hydraulics / Pneumatics general Application	-	-
		Guide Ring, TF06 Hydraulics / Pneumatics general Application	-	-
		Guide Ring, TF06G Hydraulics / Pneumatics general Application	-	-
		Guide Ring, TF07 Hydraulics / Pneumatics general Application	-	-
		Guide Ring, TF07G Hydraulics / Pneumatics general Application	-	-
		Guide Ring, TF08 Hydraulics / Pneumatics general Application	-	-
		Guide Ring, TF08G Hydraulics / Pneumatics general Application	-	-
		Guide Ring, TF09 Hydraulics / Pneumatics general Application	-	-
		Guide Ring, TF09G Hydraulics / Pneumatics general Application	-	-

Fluid Pneumatic Seals – Guide Ring Systems

Page 3 of 3 · State: 2012.03.16









Product standard application			Direction mouse over symbol	Pressure maximum	Sliding Speed. maximum
		Guide Ring, TF10 Hydraulics / Pneumatics general Application		-	-
		Guide Ring, TF10G Hydraulics / Pneumatics general Application		-	-

Fluid Pneumatic Seals – Backup Rings

Product standard application			Direction mouse over symbol	Pressure maximum	Sliding Speed. maximum
		Backup Ring, TB08 Hydraulics / Pneumatics general Application		-	-
		Backup Ring, TB08G Hydraulics / Pneumatics general Application		-	-
		Backup Ring, TB09 Hydraulics / Pneumatics general Application		-	-
		Backup Ring, TB09G Hydraulics / Pneumatics general Application		-	-
		Backup Ring, TB10 Hydraulics / Pneumatics general Application		-	-
		Backup Ring, TB10G Hydraulics / Pneumatics general Application		-	-
		Backup Ring, TB11 Hydraulics / Pneumatics general Application		-	-
		Backup Ring, TB11G Hydraulics / Pneumatics general Application		-	-
		Backup Ring, TB12 Hydraulics / Pneumatics general Application		-	-



















Fluid Pneumatic Seals – Backup Rings

Page 2 of 2 · State: 2012.03.16

















Product standard application		Direction mouse over symbol	Pressure maximum	Sliding Speed. maximum	
		Backup Ring, TB12G Hydraulics / Pneumatics general Application		-	-
		Backup Ring, TB13 Hydraulics / Pneumatics general Application		-	-
		Backup Ring, TB13G Hydraulics / Pneumatics general Application		-	-

Rotary Seals







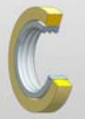











Page 1 of 4 · State: 2012.03.16

Product standard application		Direction mouse over symbol	Pressure maximum	Sliding Speed. maximum
		Rotary Seal, TR01AF Hydraulics / Pneumatics, in Steel Mills, Shipbuilding and in Heavy Hydraulic, single acting	0,5 bar	10 m/s
		Rotary Seal, TR01F Hydraulics / Pneumatics, general Application, single acting	15 bar	10 m/s
		Rotary Seal, TR01G Hydraulics / Pneumatics, in Steel Mills, Shipbuilding and in Heavy Hydraulic, single acting	-	10 m/s
		Rotary Seal, TR01P Hydraulics / Pneumatics, general Application, single acting	0,5 bar	5 m/s
		Rotary Seal, TR01R Hydraulics / Pneumatics, general Application, single acting	0,5 bar	10 m/s
		Rotary Seal, TR02P Hydraulics / Pneumatics, general Application, single acting	0,5 bar	5 m/s
		Rotary Seal, TR02R Hydraulics / Pneumatics, general Application, single acting	0,5 bar	10 m/s
		Rotary Seal, TR03P Hydraulics / Pneumatics, Mobile Hydraulics and in Rotary Distributors, double acting	0,3 bar	400 m/s
		Rotary Seal, TR03R Hydraulics / Pneumatics, Mobile Hydraulics and in Rotary Distributors, double acting	250 bar	0,2 m/s

Rotary Seals









Product standard application		Direction mouse over symbol	Pressure maximum	Sliding Speed. maximum
		Rotary Seal, TR04 Hydraulics / Pneumatics, general Application, single acting	160 bar	0,3 m/s
		Rotary Seal, TR05 Hydraulics / Pneumatics, general Application, single acting	160 bar	0,3 m/s
		Rotary Seal, TR06P General Application, axially acting	–	25 m/s
		Rotary Seal, TR06R General Application, axially acting	–	25 m/s
		Rotary Seal, TR07P General Application, axially acting	–	25 m/s
		Rotary Seal, TR07R General Application, axially acting	–	25 m/s
		Rotary Seal, TR08 General Application, axially acting	–	25 m/s
		Rotary Seal, TR09F Hydraulics / general Application, single acting	350 bar	0,4 m/s
		Rotary Seal, TR09FS Hydraulic / Pneumatic, double acting	350 bar	0,4 m/s

Rotary Seals

Product standard application		Direction mouse over symbol	Pressure maximum	Sliding Speed. maximum
		Rotary Seal, TR10F Hydraulics / Pneumatics, general Application, single acting	350 bar	0,4 m/s
		Rotary Seal, TR10FS Hydraulics / Pneumatics, general Application, single acting	350 bar	0,4 m/s
		Rotary Seal, TR11F General Application, single acting	5 bar	20 m/s
		Rotary Seal, TR11FD General Application, single acting	5 bar	20 m/s
		Rotary Seal, TR12F Food-, Pharmaceutical and- Chemical industry, single-acting	300 bar	1 m/s
		Rotary Seal, TR13 Hydraulics / Pneumatics, general Application, single acting	600 bar	-
		Rotary Seal, TR14 General Application	-	-
		Rotary Seal, TR15P Hydraulics / Pneumatics, general Application, double acting	400 bar	-
		Rotary Seal, TR19F Food-, Pharmaceutical and- Chemical industry, single-acting	150 bar	2 m/s



Rotary Seals

Page 4 of 4 · State: 2012.03.16

Product standard application		Direction mouse over symbol	Pressure maximum	Sliding Speed. maximum
		Rotary Seal, TR20P Hydraulics / Pneumatics, general Application, single acting	800 bar	-
		Rotary Seal, TR30 Oil and Offshore industry, single-acting	1000 bar	0,5 m/s
		Rotary Seal, TR35 Hydraulics / Pneumatics, general Application, axially acting	800 bar	-
		Rotary seal, TR37P Hydraulics / Pneumatics, general Application, double acting	80 bar	-















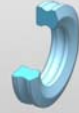









Static Seals – O-Rings

Page 1 of 1 · State: 2012.03.16

Product standard application	Direction mouse over symbol	Pressure maximum	Sliding Speed. maximum
  <p>O-RING, TR13 Hydraulics / Pneumatics general Application</p>		600 bar	-

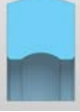
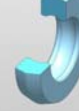









Static Seals – O-Ring Alternatives

Page 1 of 2 · State: 2012.03.16

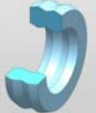
Product standard application			Direction mouse over symbol	Pressure maximum	Sliding Speed. maximum
		Axialprofile, TE01 Hydraulics / Pneumatics, double acting, general application		400 bar	–
		Axialprofile, TE02 Hydraulics / Pneumatics, double acting, general application		400 bar	–
		Axialprofile, TE03 Hydraulics / Pneumatics, double acting, general application		600 bar	–
		Axialprofile, TE04 Hydraulics / Pneumatics, double acting, general application		400 bar	–
		Axialprofile, TE05 Hydraulics / Pneumatics, double acting, general application		400 bar	–
		Pistonprofile, TK15P Hydraulics / Pneumatics, double acting, general application		400 bar	–
		Pistonprofile, TK20R Hydraulics / Pneumatics, double acting, general application		700 bar	–
		Pistonprofile, TK35P Hydraulics / Pneumatics, double acting, general application		400 bar	–
		Quadring / X-Ring, TK37R Hydraulics / Pneumatics, double acting, general application		50 bar	–

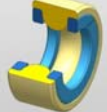













Static Seals – O-Ring Alternatives

Page 2 of 2 · State: 2012.03.16

Product standard application			Direction mouse over symbol	Pressure maximum	Sliding Speed. maximum
		Square Ring, TR14R Hydraulics / Pneumatics, double acting, general application		1000 bar	–
		Rodprofile, TS15P Hydraulics / Pneumatics, double acting, general application		400 bar	–
		Rodprofile, TS20R Hydraulics / Pneumatics, double acting, general application		700 bar	–
		Rodprofile, TS35P Hydraulics / Pneumatics, double acting, general application		400 bar	–



Static Seals – Gaskets

Page 1 of 1 · State: 2012.03.16

Product standard application			Direction mouse over symbol	Pressure maximum	Sliding Speed. maximum
		Flat Gasket, TG01 Chemical / Pharmaceutical Industry, Valves and Fittings, Hydraulics / Pneumatics, Mechanical Engineering, General Application		-	-
		Flat Gasket, TG02 Chemical / Pharmaceutical Industry, Valves and Fittings, Hydraulics / Pneumatics, Mechanical Engineering, General Application		-	-
		Flat Gasket, TG03 Chemical / Pharmaceutical Industry, Valves and Fittings, Hydraulics / Pneumatics, Mechanical Engineering, General Application		-	-
		Flat Gasket, TG04 Chemical / Pharmaceutical Industry, Valves and Fittings, Hydraulics / Pneumatics, Mechanical Engineering, General Application		-	-
		Flat Gasket, TG05 Chemical / Pharmaceutical Industry, Valves and Fittings, Hydraulics / Pneumatics, Mechanical Engineering, General Application		-	-











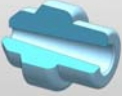



Large Diameter Seals

Page 1 of 1 · State: 2012.03.16



Product standard application	Direction mouse over symbol	Pressure maximum	Sliding Speed. maximum
 <p data-bbox="492 311 952 406">Product group, (TS, TA, TB, TF, TK, TR) Hydraulics / Pneumatics general Application</p>		-	-

Miniature Seals

Page 1 of 1 · State: 2012.03.16

Product standard application			Direction mouse over symbol	Pressure maximum	Sliding Speed. maximum
		Miniature Seal, TE99 (example)		-	-
		Miniature Seal, TE99 (example)		-	-
		Miniature Seal, TE99 (example)		-	-
		Miniature Seal, TE99 (example)		-	-
		Miniature seal, TE99 (example)		-	-

Special Profiles

Product standard application	Direction mouse over symbol	Pressure maximum	Sliding Speed. maximum
 vacuum special component, TE99 (example)		-	-